

**MECCANO**<sup>TM</sup>  
M A K E R S Y S T E M

**RACE CARS  
COURSE AUTOMOBILE**

16208



**8+**

**Instructions  
Notice de montage  
Instrucciones de construcción  
Bauanleitung**

**Bouwinstructie  
Istruzioni  
Instruções  
Инструкции**



 **CONSTRUCTION TIPS / ASTUCES DE CONSTRUCTION**  
TIPS DE CONSTRUCCIÓN / TIPPS ZUM BAUEN  
MONTAGETIPS / SUGGERIMENTI PER COSTRUIRE  
DICAS DE MONTAGEM / РЕКОМЕНДАЦІЇ ПО СБОРКЕ

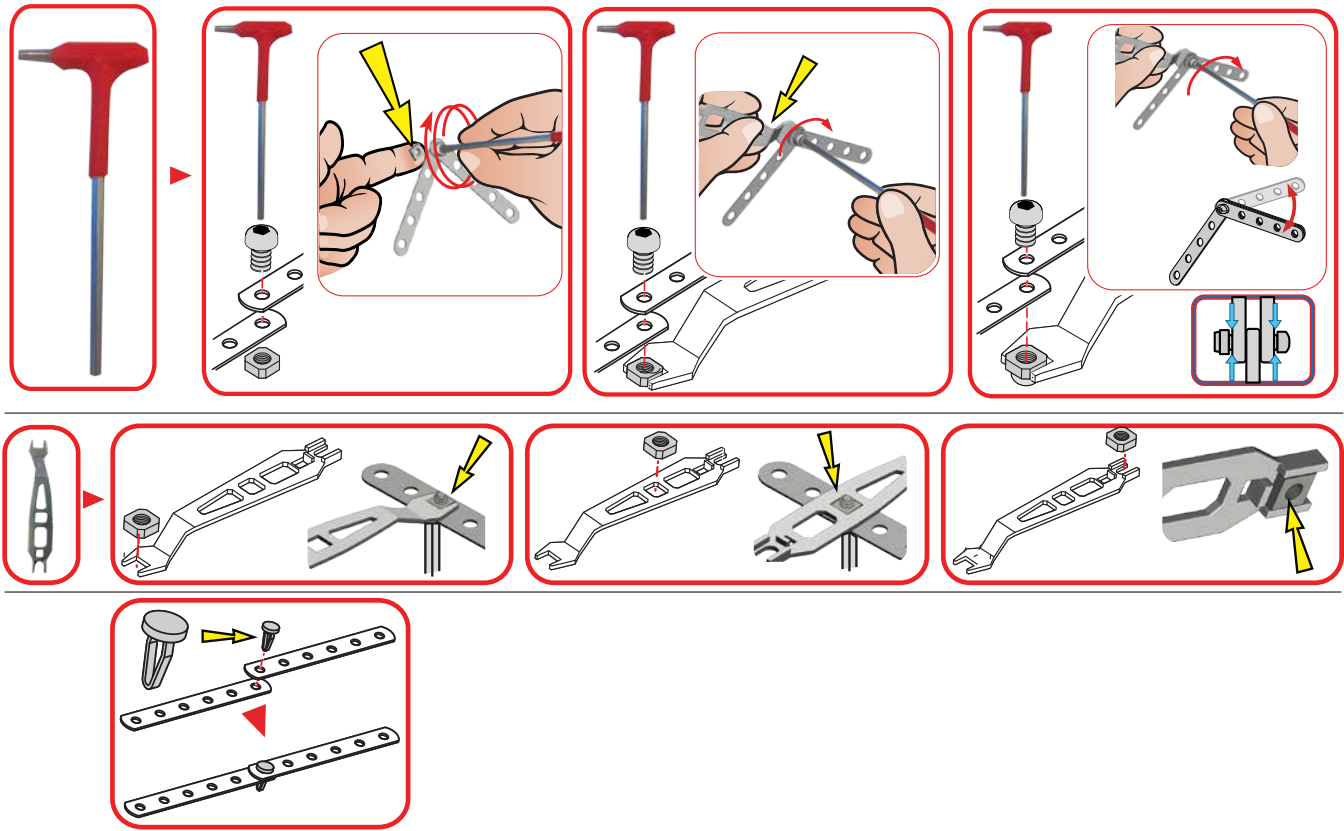

# TABLE OF CONTENTS / SOMMAIRE

## ÍNDICE / INHALTSVERZEICHNIS / INHOUD / INDICE / ÍNDICE / СОДЕРЖАНИЕ



4



14



19

**AVAILABLE ONLINE / DISPONIBLES EN LIGNE**  
**DISPONIBLES EN LÍNEA / ONLINE VERFÜGBAR /**  
**ONLINE VERKRIJGBAAR / DISPONIBILI ONLINE /**  
**DISPONÍVEL ONLINE / ДОСТУПНЫ В**  
**ОНЛАЙН-МАГАЗИНЕ**







**EN.** Content : 162 parts, 2 real tools and 1 instruction sheet for 3 models.  
**FR.** Contenu : 162 pièces, 2 vrais outils et 1 notice de montage pour 3 modèles.  
**ES.** Contenido : 162 piezas, 2 herramientas reales y 1 guía de instrucciones para 3 modelos.  
**DE.** Inhalt: 162 Teile, 2 echte Werkzeuge und 1 Bauanleitung für 3 Modelle.  
**NL.** Inhoud : 162 onderdelen, 2 stuks gereedschap en 1 bouw instructie voor 3 modellen.  
**IT.** Contenuto : 162 pezzi, 2 attrezzi e 1 guida per l'uso per 3 modelli.  
**PT.** Conteúdo: 162 peças, 2 ferramentas reais e 1 folha de instruções para 3 modelos.  
**RU.** В коробке: 162 детали, 2 настоящих инструмента и 1 инструкция по сборке 3 моделей.

**EN.** Building instructions for the 2 other models are available at [www.meccano.com](http://www.meccano.com).  
**FR.** Les notices de montage des 2 autres modèles sont disponibles sur [www.meccano.com](http://www.meccano.com).  
**ES.** Hay instrucciones de construcción disponibles para los otros 2 modelos en [www.meccano.com](http://www.meccano.com).  
**DE.** Bauanleitungen für die anderen 2 Modelle sind auf [www.meccano.com](http://www.meccano.com) zu finden.  
**NL.** Bouwinstructies voor de andere 2 modellen zijn beschikbaar op [www.meccano.com](http://www.meccano.com).  
**IT.** Le istruzioni di montaggio degli altri 2 modelli sono disponibili alla pagina [www.meccano.com](http://www.meccano.com).  
**PT.** Instruções de montagem dos restantes 2 modelos disponíveis em [www.meccano.com](http://www.meccano.com).  
**RU.** Инструкции по сборке 2 других моделей можно найти на сайте [www.meccano.com](http://www.meccano.com).

**EN.** Only one model can be built at a time. **FR.** Les pièces fournies ne permettent de monter qu'un seul modèle à la fois. **ES.** Solo es posible construir un modelo a la vez. **DE.** Jeweils nur eins der Modelle baubar. **NL.** Er kan maar een model tegelijk worden gebouwd. **IT.** Permette di realizzare un solo modello per volta. **PT.** Só é possível montar um modelo de cada vez. **RU.** Одновременно можно построить только одну модель.



1





-  S1 | 5.8 mm | x4  
15/64"
-  x4
-  x1
-  x2
-  x1

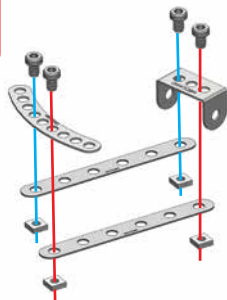

-  S1 | 1:1





2

-  S1 | 5.8 mm | x2  
15/64"
-  x2
-  x1
-  x2

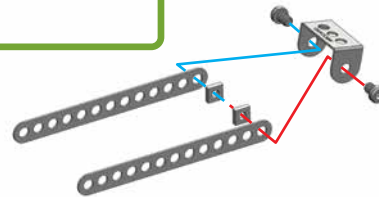
-  S1 | 1:1







**3****①+②+**

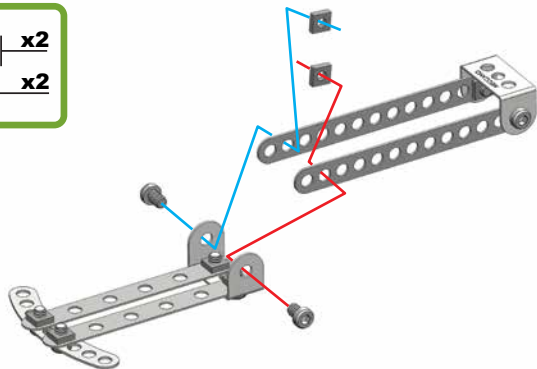

	<b>S1</b>   5,8 mm   <b>x2</b> 15/64"
	<b>x2</b>

	<b>S1</b>   <b>1:1</b>
---	------------------------

**4**

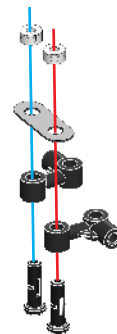

	<b>x2</b>
	<b>x2</b>
	<b>x2</b>
	<b>x1</b>

**5****③+④+**

	<b>B1</b>   14,7 mm   <b>x2</b> 37/64"
	<b>x2</b>
	<b>x4</b>

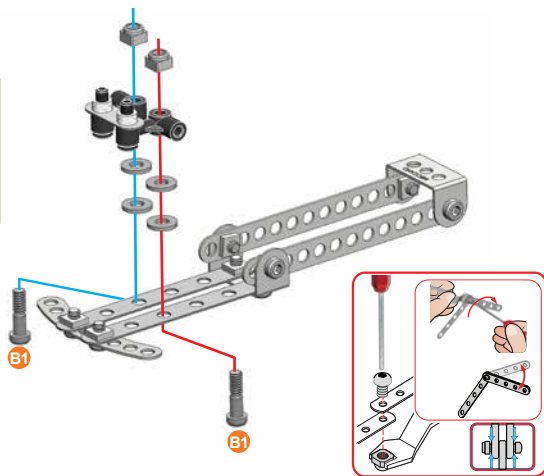
	<b>B1</b>   <b>1:1</b>
---	------------------------



**6**

	<b>S1</b>   5,8 mm   <b>x2</b> 15/64"
	<b>x2</b>
	<b>x1</b>

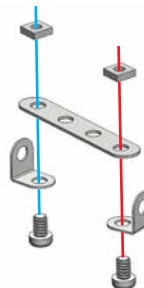
	<b>S1</b>   <b>1:1</b>
---	------------------------

**5**



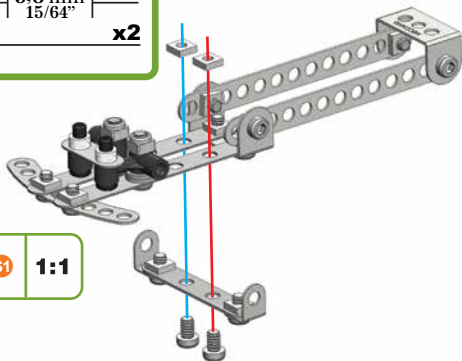

**7****⑤+⑥+**



 <b>S1</b>   5.8 mm   <b>x2</b> 15/64"	 <b>x2</b>
--	---







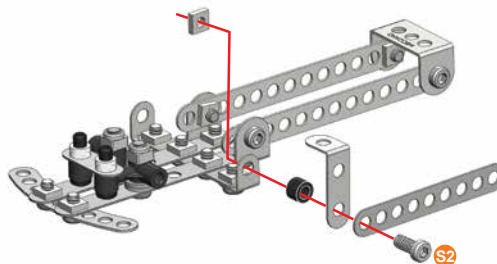

 <b>S1</b>	<b>1:1</b>
---	------------

**8**

 <b>S2</b>   9.5 mm   <b>x1</b> 3/8"	 <b>x1</b>
 <b>x1</b>	 <b>x1</b>
 <b>x1</b>	



 <b>S2</b>	<b>1:1</b>
 <b>A338</b>	

**9**

 <b>S2</b>   9.5 mm   <b>x1</b> 3/8"	 <b>x1</b>
 <b>x1</b>	 <b>x1</b>
 <b>x1</b>	

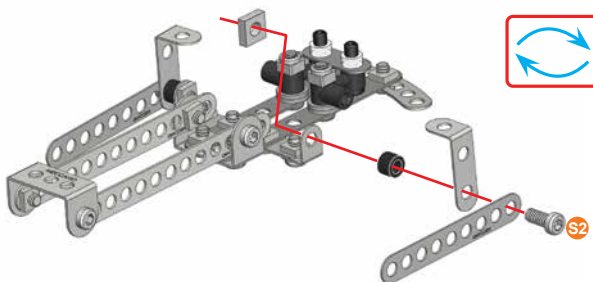
 <b>S2</b>	<b>1:1</b>
 <b>A338</b>	

**10**



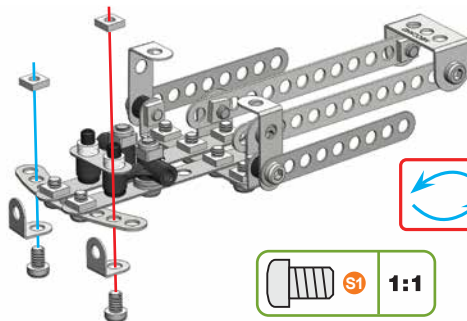

 <b>S1</b>   5.8 mm   <b>x2</b> 15/64"	 <b>x2</b>
---	---



 <b>S1</b>	<b>1:1</b>
---	------------

**6**



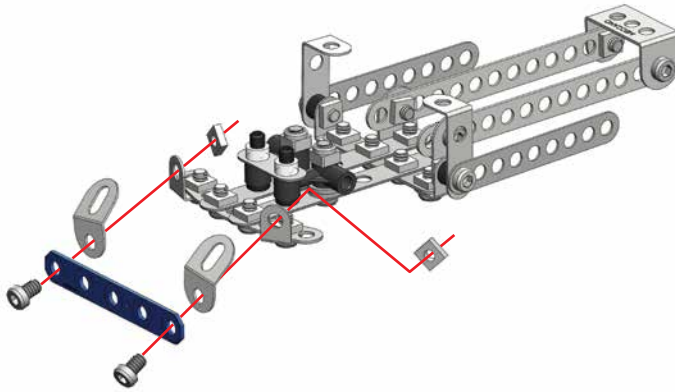

11

-  | 5.8 mm | x2  
15/64"
-  | x2
-  | x2
-  | x1
-  | x1

-  | 1:1





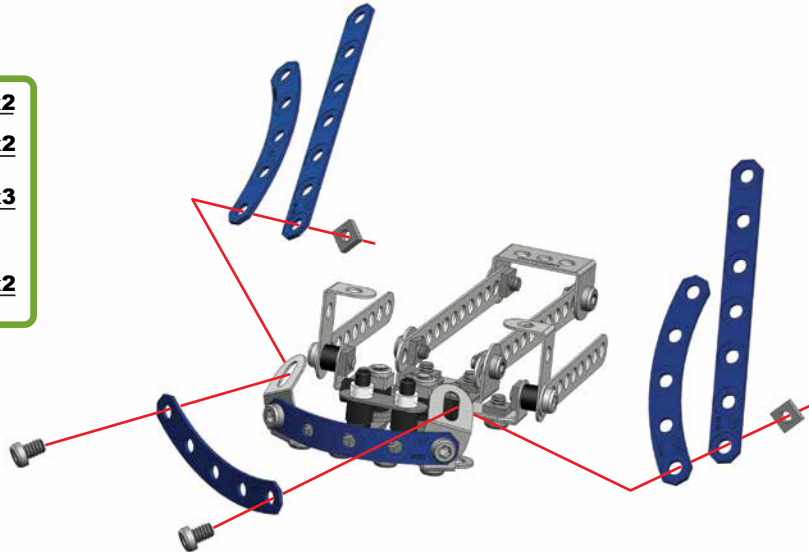

12

-  | 5.8 mm | x2  
15/64"
-  | x2
-  | x3
-  | x2

-  | 1:1



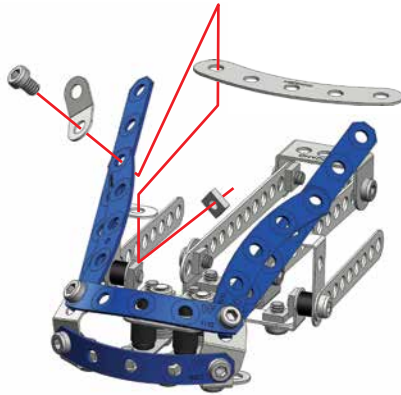

# 13

-  | 5,8 mm | **x1**  
15/64"
-  | **x1**
-  | **x1**
-  | **x1**





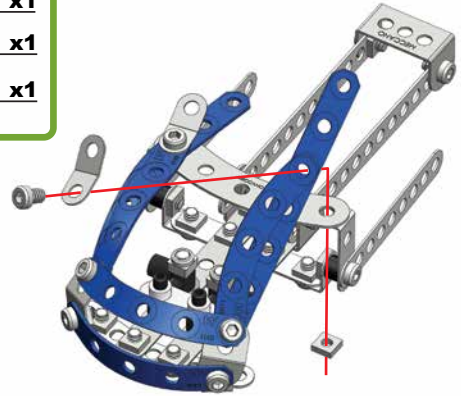

# 14

-  | 5,8 mm | **x1**  
15/64"
-  | **x1**
-  | **x1**





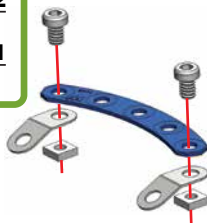

# 15



-  | 5,8 mm | **x2**  
15/64"
-  | **x2**
-  | **x2**
-  | **x1**



# 16

(14)+(15)+





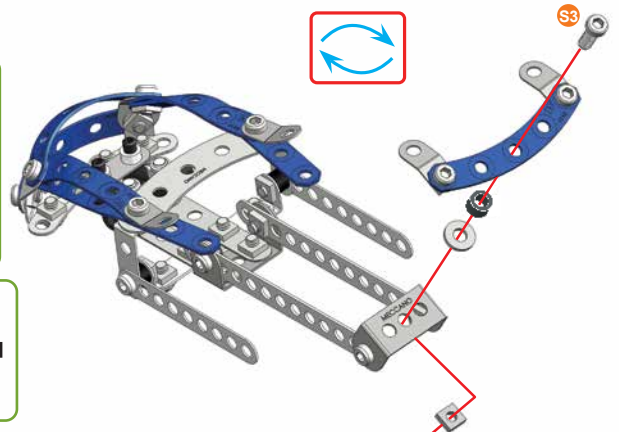

-  | 12 mm | **x1**  
1/2"
-  | **x1**
-  | **x1**
-  | **x1**

-   **A338**
-  | **x1**  
**S3**









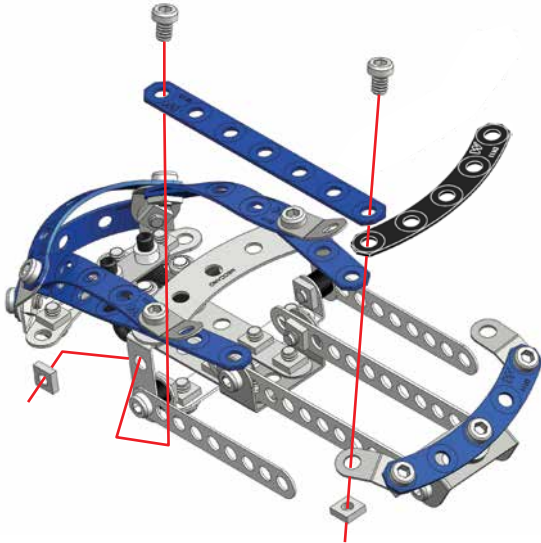

17

-  **S1** | 5.8 mm | **x2**  
15/64"
-  **x2**
-  **x1**  

-  **x1**  

-  **S1** | **1:1**





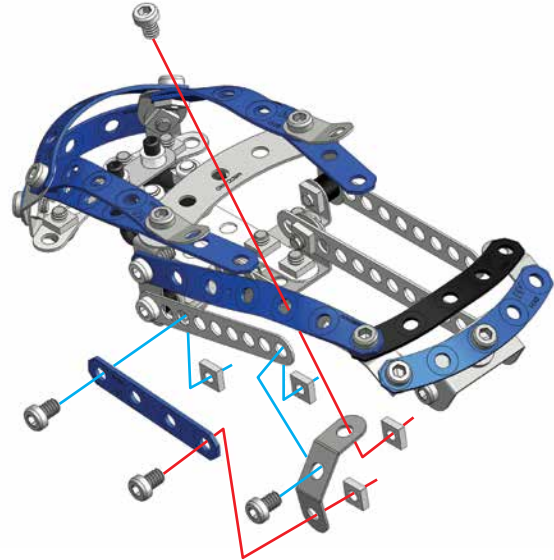

18

-  **S1** | 5.8 mm | **x4**  
15/64"
-  **x4**
-  **x1**
-  **x1**  

-  **S1** | **1:1**



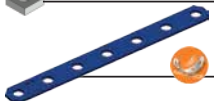

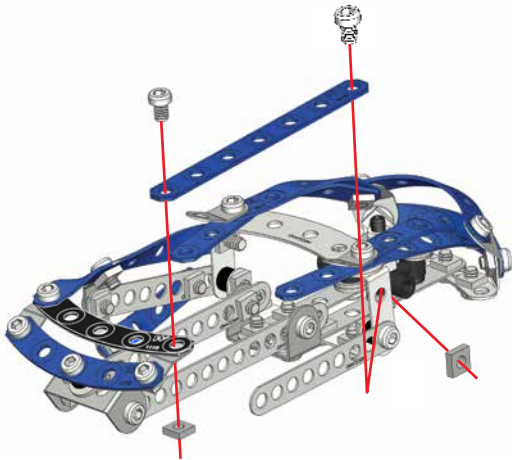

19

-  S1 | 5.8 mm | x2  
15/64"
-  x2
-  x1
-  x1



20

-  S1 | 5.8 mm | x4  
15/64"
-  x4
-  x1
-  x1
-  x1

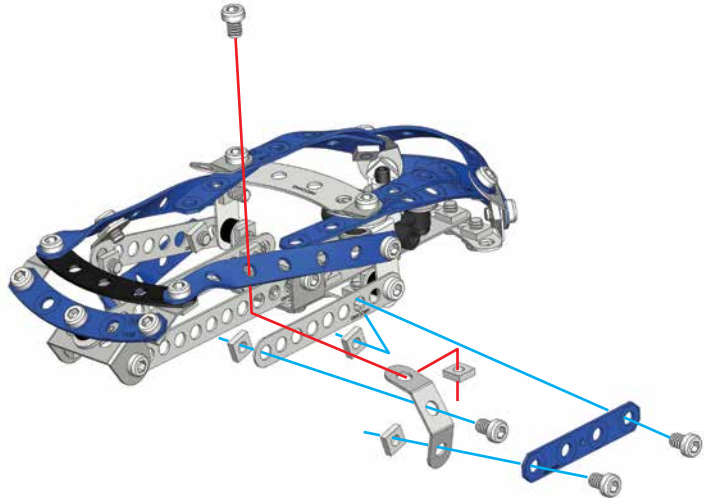

21

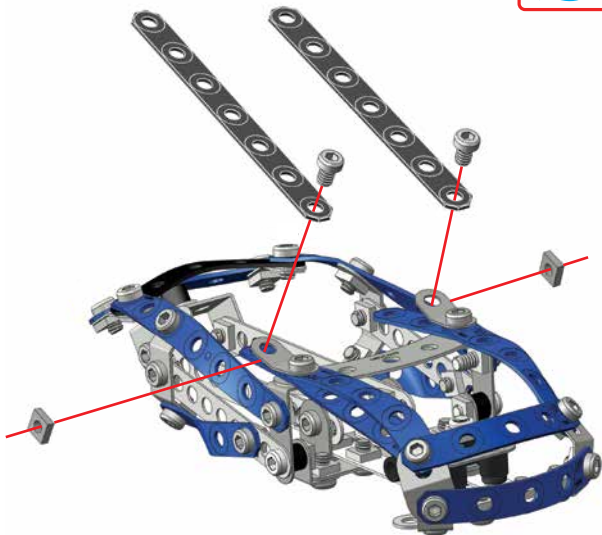
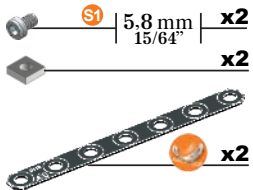

22

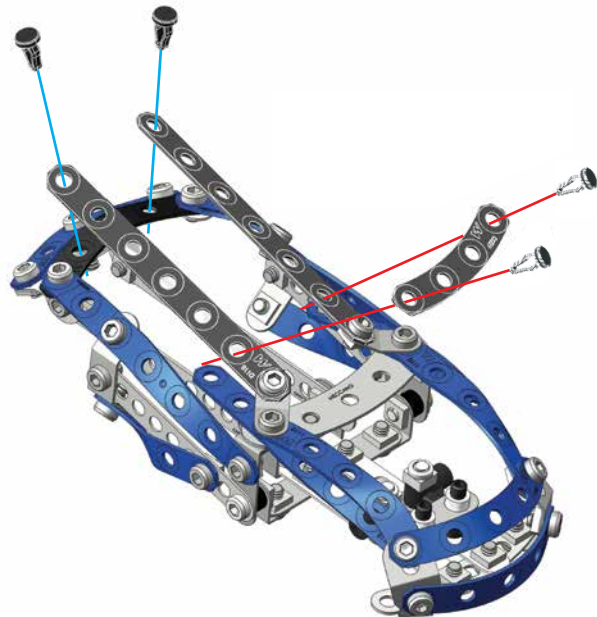
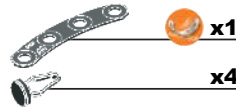

23

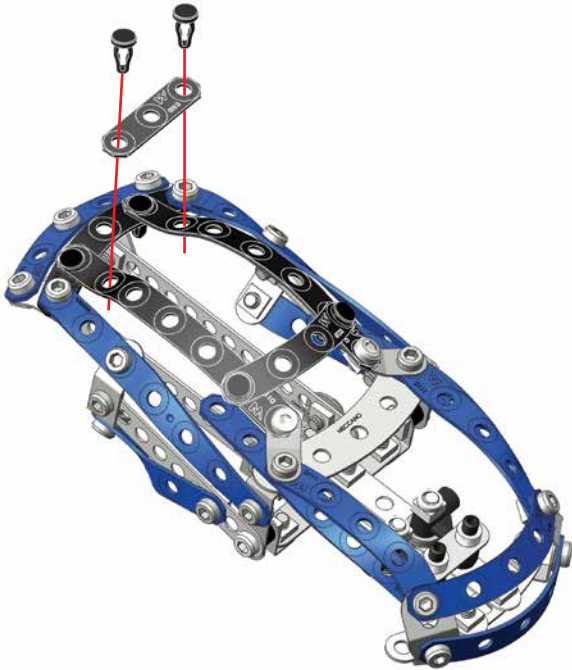
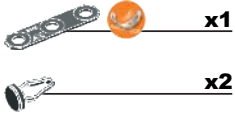

24

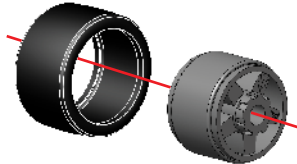
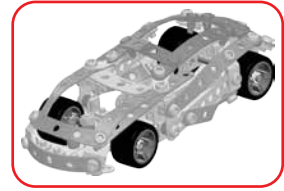
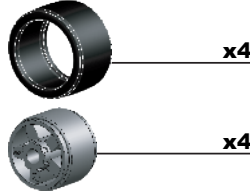

25

23+24+

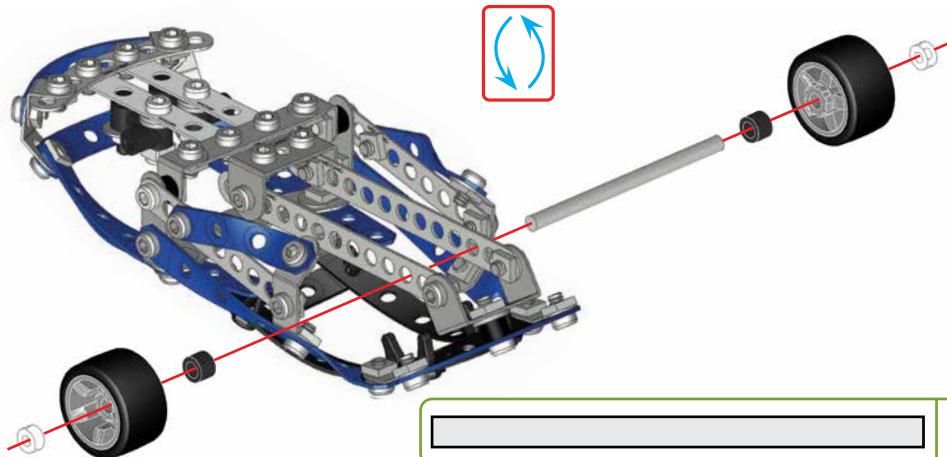
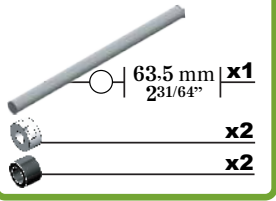

26

24+25+

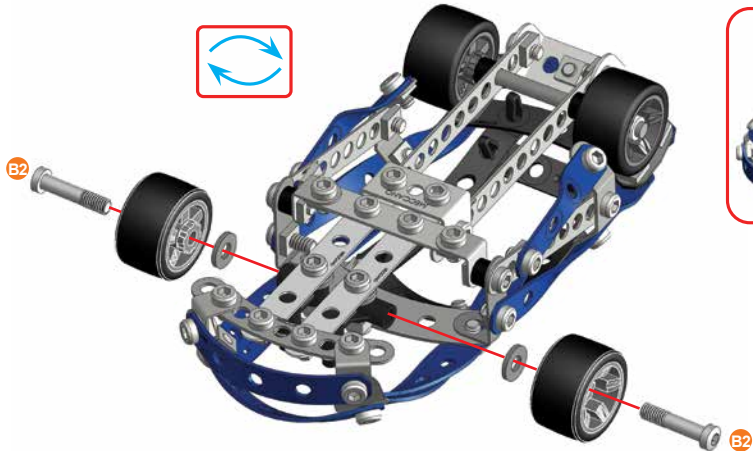
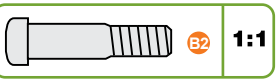
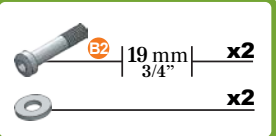



# 1

	5.8 mm 15/64"	<b>x4</b>
		<b>x4</b>
		<b>x2</b>
		<b>x2</b>
		<b>x2</b>

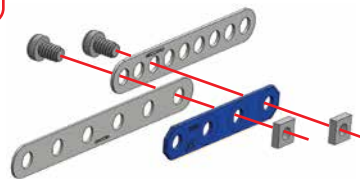

# 2

	5.8 mm 15/64"	<b>x4</b>
		<b>x4</b>
		<b>x4</b>
		<b>x2</b>

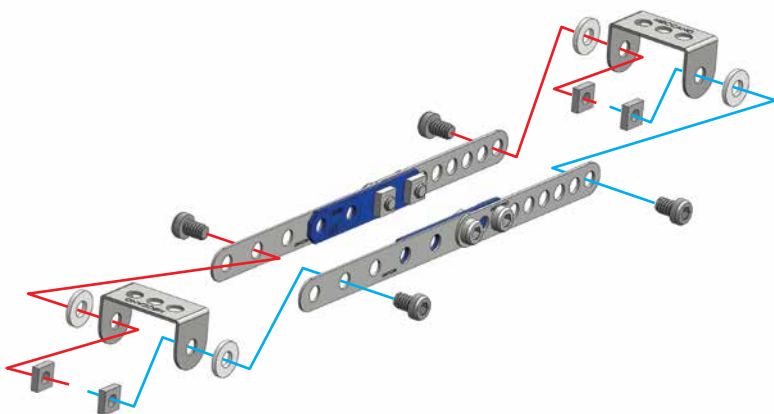

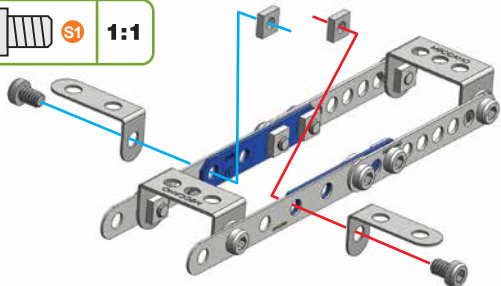
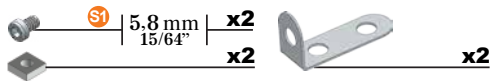
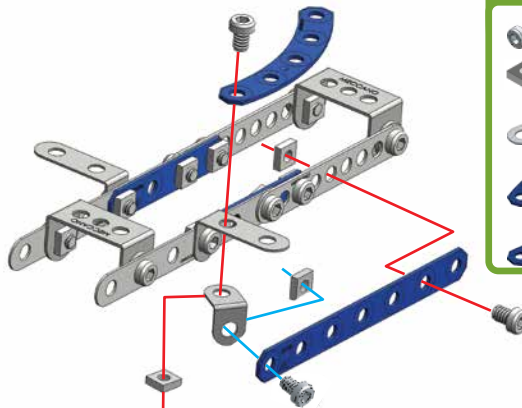
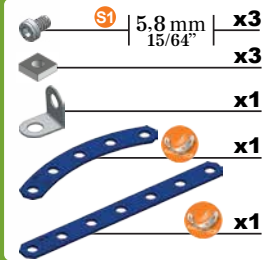
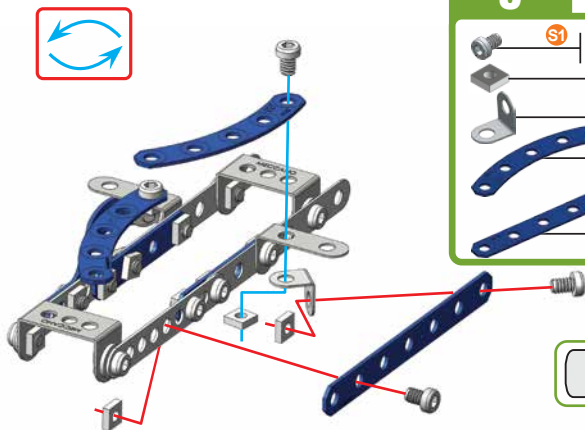
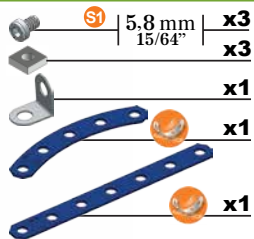
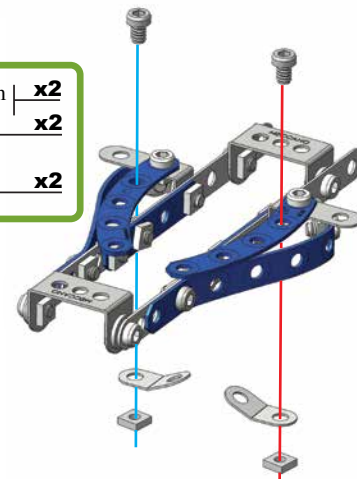
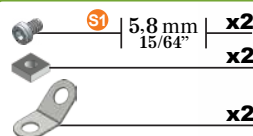
**3****4****5****6**

### 7

	S1	5.8 mm	x1
		15/64"	x1
			x1
			x1

	S1	1:1
--	----	-----

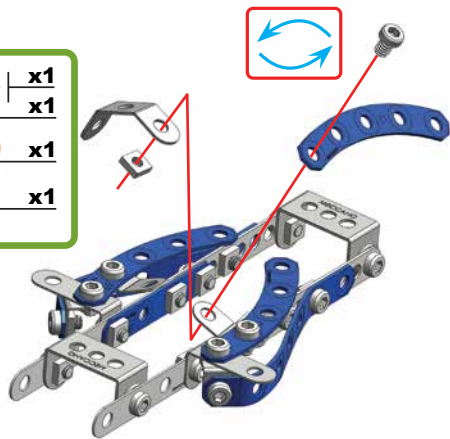

### 8

	S1	5.8 mm	x1
		15/64"	x1
			x1

	S1	1:1
--	----	-----

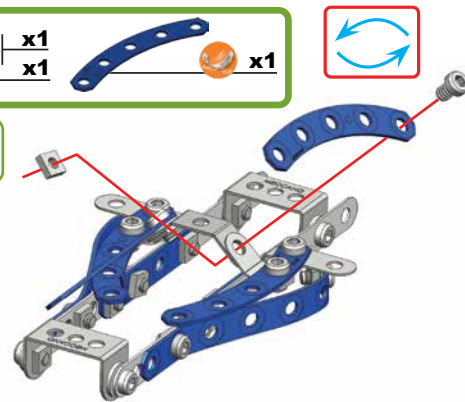

### 9

	S1	5.8 mm	x1
	S2	9.5 mm	x1
		3/8"	x2
			x1
			x1

	S2	1:1
		A338

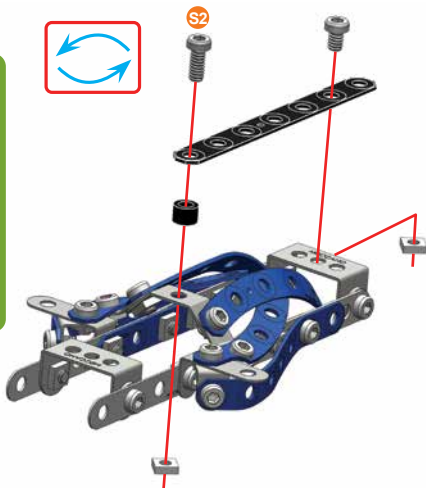

### 10

	S2	9.5 mm	x1
		3/8"	x1
			x1
			x1



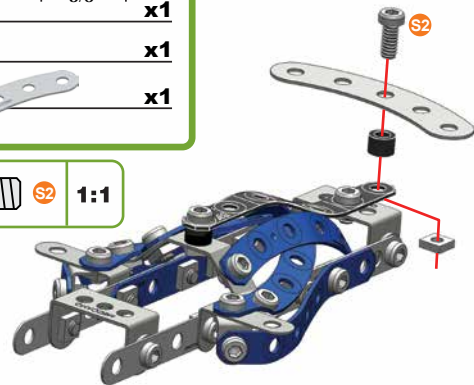

	S2	1:1
--	----	-----

		A338	1:1
--	--	------	-----







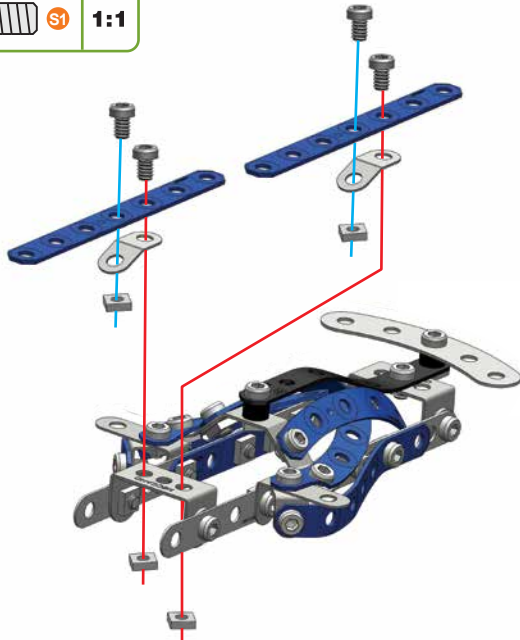

# 11

-  **S1** | 5.8 mm | **x4**  
15/64"
-  **x4**
-  **x2**
-  **x2**

 **S1** | **1:1**





# 12

-  **S1** | 5.8 mm | **x2**  
15/64"
-  **x2**
-  **x1**

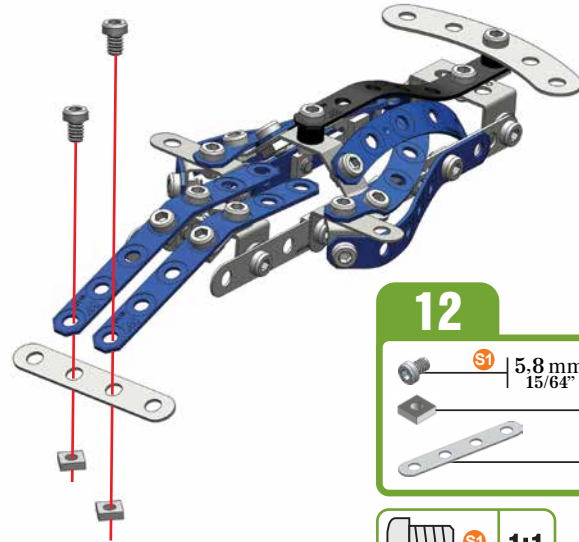
 **S1** | **1:1**



# 13

-  **x4**
-  **x4**

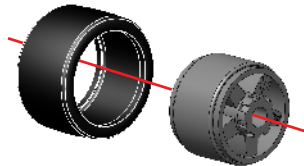
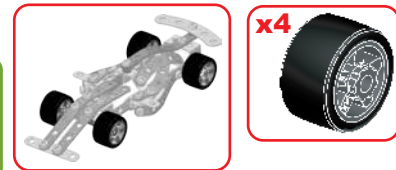

14

(12)+(13)+

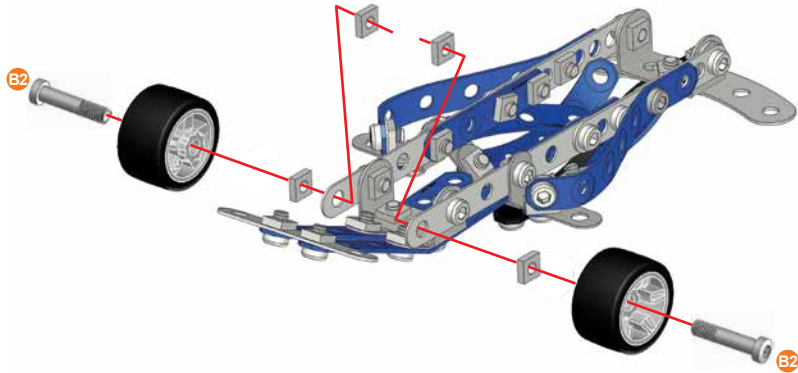
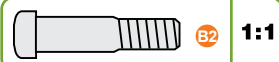
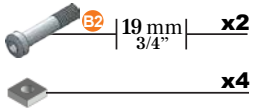



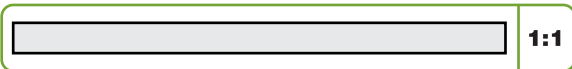
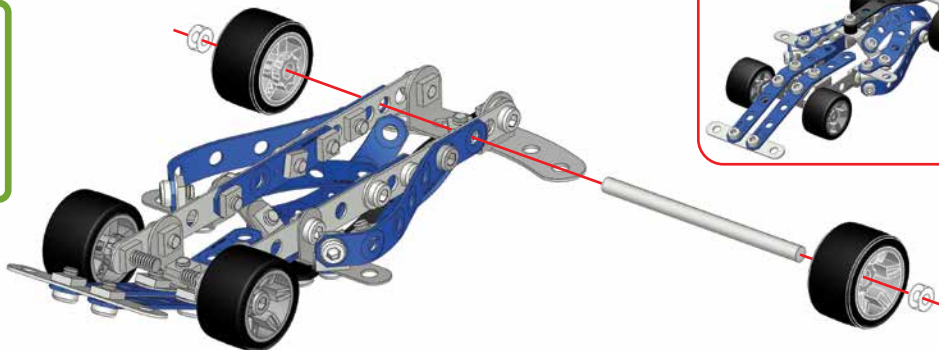
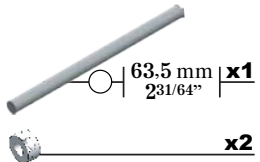

15

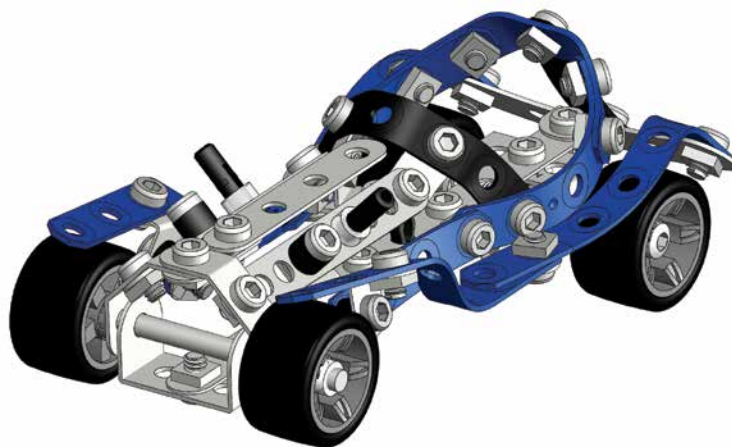
(13)+(14)+







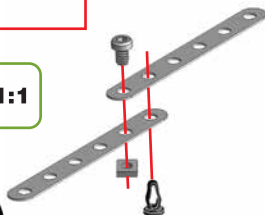
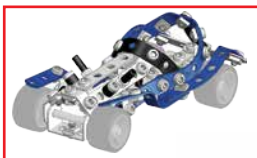

1

-  **S1** | 5.8 mm | **x1**  
15/64"
-  **x1**
-  **x1**
-  **x2**





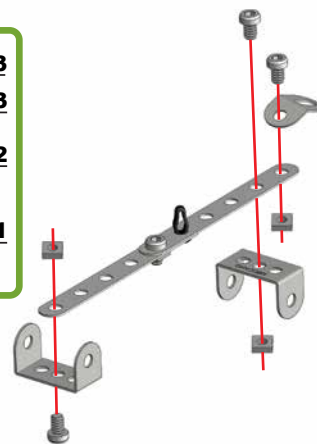

2

-  **S1** | 5.8 mm | **x3**  
15/64"
-  **x3**
-  **x2**
-  **x1**







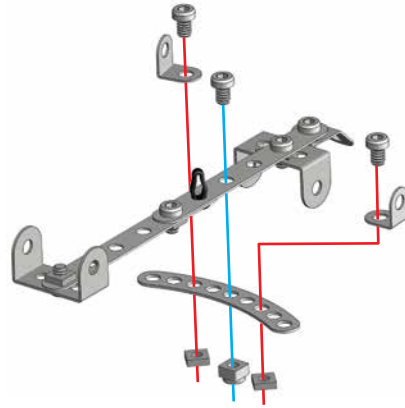
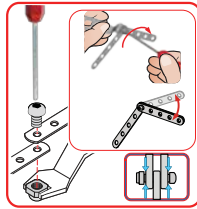



### 3

-  **S1** | 5.8 mm | **x3**  
15/64"
-  **x2**
-  **x1**
-  **x2**
-  **x1**



**S1** 1:1

### 4







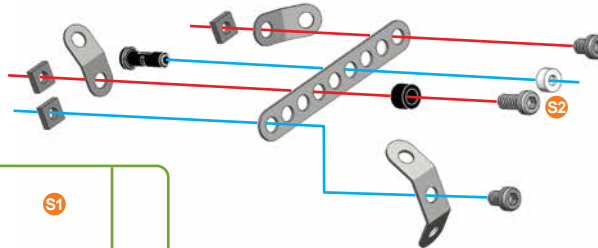

-  **S1** | 5.8 mm | **x2**  
15/64"
-  **S2** | 9.5 mm | **x1**  
3/8"
-  **x3**
-  **x1**
-  **x1**
-  **x2**
-  **x1**
-  **x1**
-  **x1**





**S1**  
**S2**  
**A338** 1:1



# 5



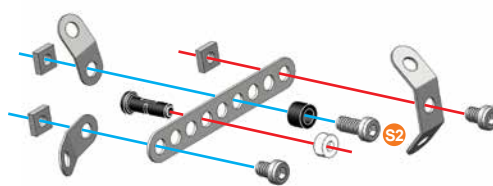

 S1	5.8 mm 15/64"	x2		x2
 S2	9.5 mm 3/8"	x1		x1
		x3		x1
 S1		x1		x1
 S1		x1		

 S1	1:1
 S2	
 A338	



# 6

(4)+(5)+

 S1	5.8 mm 15/64"	x2		x2
		x1		x1
		x1		x1

 S1	1:1
--	-----

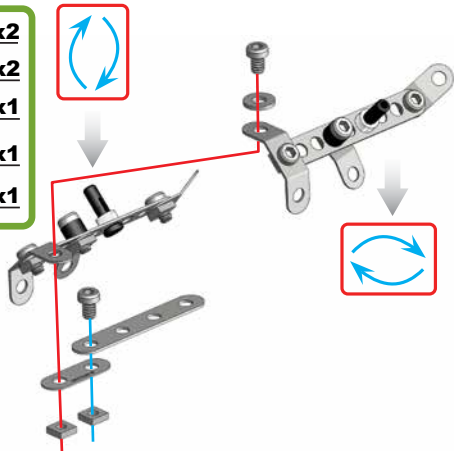

# 7

 S1	5.8 mm 15/64"	x2		x1
		x2		x1

 S1	1:1
--	-----

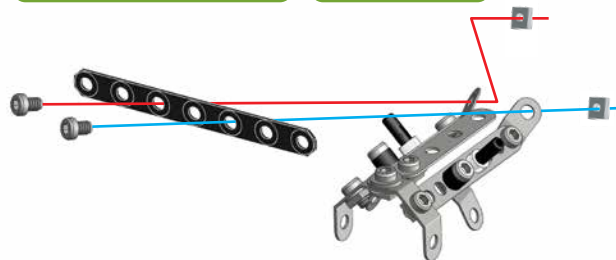

**8****③+⑦+**

	S1	5.8 mm	x2
		15/64"	

			x2
---	--	--	----

		x2
---	---	----

		63.5 mm	x1
		2 31/64"	

	S1	1:1
---	----	-----

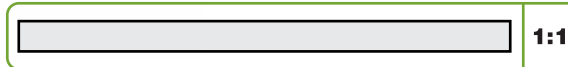
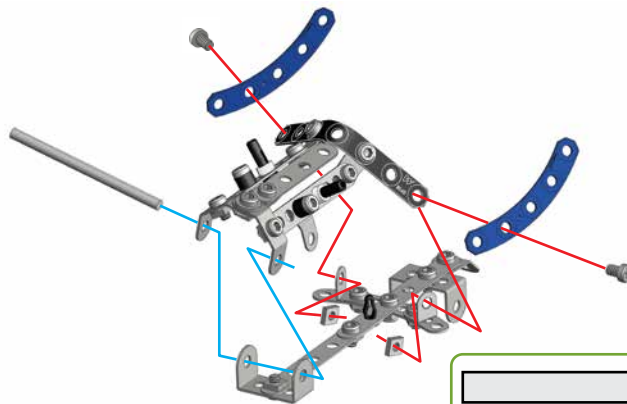
**9**

	S1	5.8 mm	x1
		15/64"	

	B1	14.7 mm	x1
		37/64"	





			x2
---	--	--	----

			x1
---	--	--	----

			x1
---	--	--	----







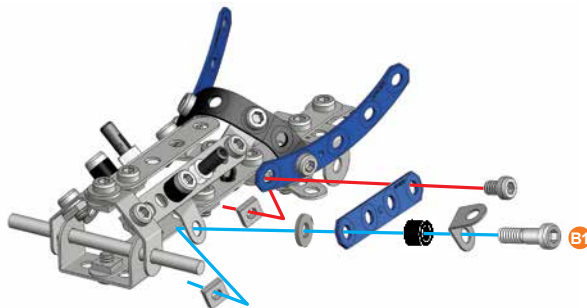

			x1
---	--	--	----





		x1
---	---	----

		A338	1:1
	B1		
	S1		





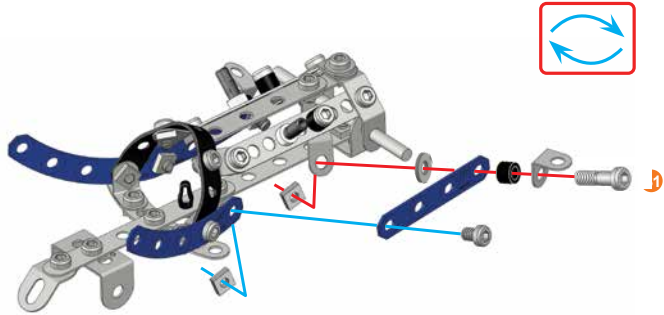

# 10

-  **S1** | 5.8 mm | **x1**  
15/64"
-  **B1** | 14.7 mm | **x1**  
37/64"
-  **x2**
-  **x1**
-  **x1**
-  **x1**
-  **x1**
-  **x1**

-  **A338**
- 
-  **B1** | **1:1**
-  **S1**



# 11

-  **S1** | 5.8 mm | **x5**  
15/64"
-  **x5**
-  **x1**
-  **x1**

-  **S1** | **1:1**

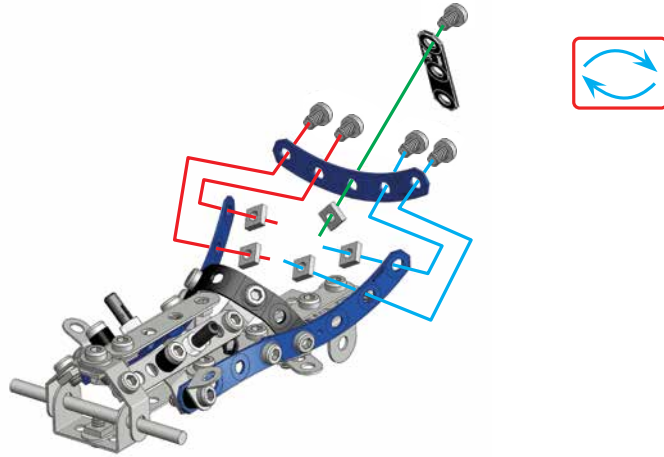

12

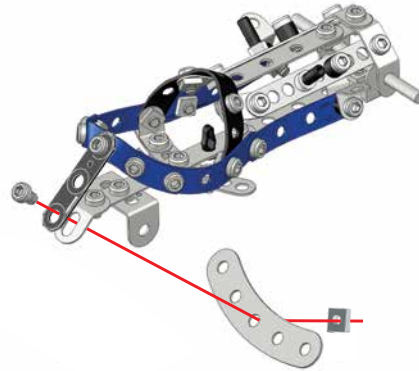
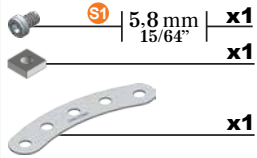

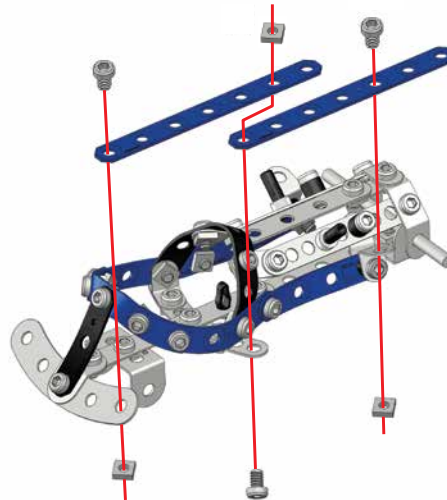
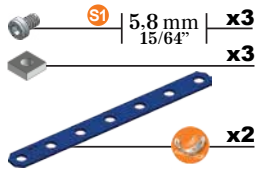

13





14

 S1 | 5.8 mm | **x3**  
 | **x3**

 **x2**

 S1 | **1:1**

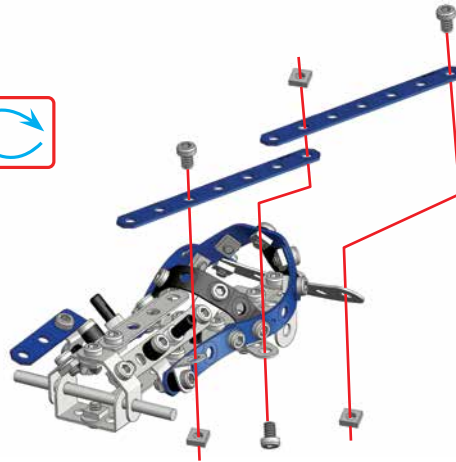

15

 **x4**

 **x4**

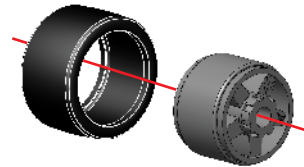
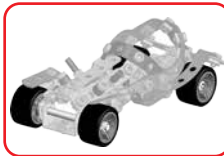



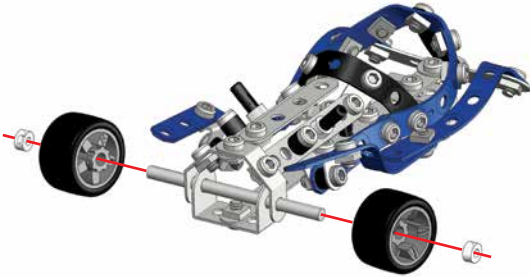

**16** (14)+(15)+

	x2
---	----



**17** (15)+(16)+

	19 mm 3/4"	x2
		x4
		x2

	B2	1:1
---	----	-----

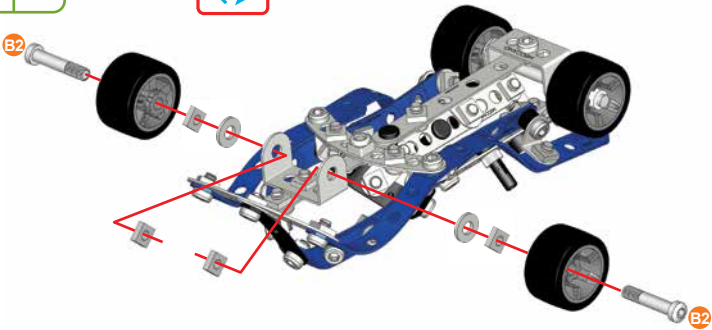



**A806 x2**



**D100 x1**

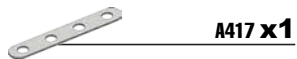

**A417 x1**



**D104 x2**

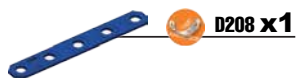

**D208 x1**

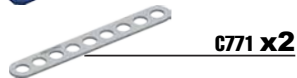

**C771 x2**



**A413 x2**



**C773 x2**

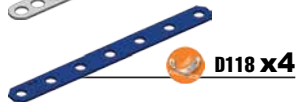

**D118 x4**

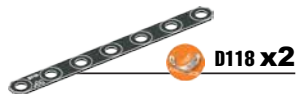

**D118 x2**



**D229 x1**

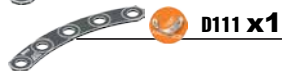

**D111 x1**



**D111 x4**



**A286 x1**



**C777 x1**



**A421 x2**



**D005 x6**

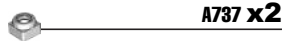

**A737 x2**



**A259 x4**

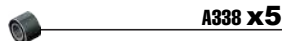

**A338 x5**



**A337 x39**



**A198 x7**



**C330 x4**



**A712 x2**



**C483 x4**



**A812 x2**



**C331 x2**



**A548 x2**



**A423 x2**



**D221 x4**



**D220 x4**

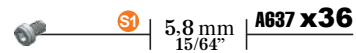

**S1** | 5.8 mm | **A637 x36**  
15/64"

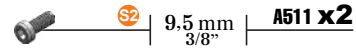

**S2** | 9.5 mm | **A511 x2**  
3/8"

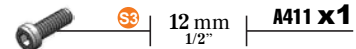

**S3** | 12 mm | **A411 x1**  
1/2"

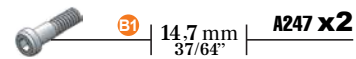

**B1** | 14.7 mm | **A247 x2**  
37/64"

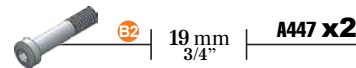

**B2** | 19 mm | **A447 x2**  
3/4"

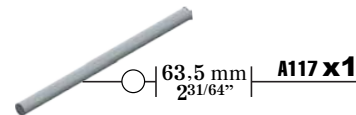

63.5 mm | **A117 x1**  
2 31/64"

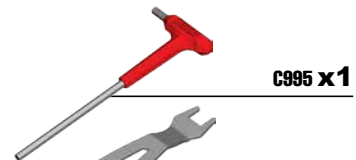

**C995 x1**

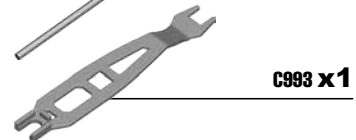

**C993 x1**

**EN.** Remove all packaging before use. Retain this information, addresses and phone numbers for future reference. Content may vary from pictures. Meccano reserves the right to discontinue the website [www.meccano.com](http://www.meccano.com) at any time. An adult should periodically check this toy to ensure no damage or hazards exist, if so, remove from use. Children should be supervised during play.

**FR.** Retirer tout l'emballage avant utilisation. Conserver les informations, adresses et numéros de téléphone pour consultation ultérieure. Le contenu peut différer des images. Meccano se réserve le droit de supprimer le site Internet [www.meccano.com](http://www.meccano.com) à tout moment. Un adulte doit régulièrement examiner ce jouet afin de s'assurer qu'il ne présente pas de dommage ni de risque. En cas de problème, ne plus l'utiliser. Les enfants doivent être surveillés lorsqu'ils jouent.

**ES.** Retire todo el embalaje antes de utilizar el producto. Conserve toda la información, las direcciones y los números de teléfono para futuras referencias. El contenido del paquete puede no corresponder con las imágenes. Meccano se reserva el derecho a suspender el sitio web [www.meccano.com](http://www.meccano.com) en cualquier momento. Un adulto debe revisar de forma periódica el juguete para asegurarse de que no supone un riesgo o peligro para el niño; si así fuera el caso, interrumpa su uso. Supervise a los niños mientras juegan con el producto.

**DE.** Entfernen Sie vor der Benutzung sämtliche Verpackungsmaterialien. Alle Informationen, Adressen und Telefonnummern bitte für mögliche Rückfragen aufbewahren. Der Packungsinhalt kann von den Bildern abweichen. Meccano behält sich das Recht vor, den Betrieb der Website [www.meccano.com](http://www.meccano.com) jederzeit einzustellen. Ein Erwachsener sollte regelmäßig sicherstellen, dass das Spielzeug keine Gefahr darstellt, und es gegebenenfalls entfernen. Kinder sollten beim Spielen beaufsichtigt werden.

**NL.** Verwijder de verpakking voor gebruik. Bewaar deze informatie, adressen en telefoonnummers voor toekomstig gebruik. Inhoud kan afwijken van illustraties. Meccano behoudt zich het recht voor de website [www.meccano.com](http://www.meccano.com) wanneer gewenst buiten gebruik te stellen. Een volwassene dient dit speelgoed regelmatig te controleren. In geval van schade of gevaren het speelgoed niet meer gebruiken. Houd toezicht als kinderen spelen.

**IT.** Rimuovere l'imballo prima dell'uso. Conservare informazioni, indirizzi e numeri di telefono per riferimento futuro. Il prodotto potrebbe essere differente dalle immagini. Meccano si riserva il diritto di rimuovere il sito [www.meccano.com](http://www.meccano.com) in qualsiasi momento. Il giocattolo deve essere periodicamente controllato da un adulto per prevenire eventuali danni o rischi; in caso di danno, sospendere l'uso. I bambini devono essere sorvegliati durante il gioco.

**PT.** Remova totalmente a embalagem antes de utilizar. Guarde todos os endereços, números de telefone e demais informações para consulta e referência. O conteúdo poderá ser diferente das ilustrações. A Meccano reserva-se o direito de descontinuar o site [www.meccano.com](http://www.meccano.com) a qualquer altura. Um adulto deve verificar o brinquedo periodicamente para garantir que não há danos ou riscos. Se houver, é necessário que o brinquedo seja retirado de uso. Crianças devem ser supervisionadas enquanto brincam.

**RU.** Снимите все упаковочные материалы перед использованием. Запишите указанные на упаковке адреса и номера телефонов, чтобы у вас была возможность связаться с нами. Содержимое упаковки может отличаться от иллюстрации. Компания Meccano оставляет за собой право прекратить использование сайта [www.meccano.com](http://www.meccano.com) в любое время. Взрослым следует время от времени проверять игру и следить за тем, чтобы она не была сломана и не представляла опасности для ребенка. В противном случае ее не следует использовать. Во время игры дети должны находиться под присмотром взрослых.

- ⚠ Warning: CHOKING HAZARD – Small parts.
- ⚠ Attention ! RISQUE D'ÉTOUFFEMENT – Contient de petits éléments.
- ⚠ Advertencia: PELIGRO DE ASFIXIA – Contiene piezas pequeñas. No conveniente para niños menores de 3 años.
- ⚠ Achtung: ERSTICKUNGSGEFAHR – Kleinteile.
- ⚠ Waarschuwing: VERSTIKKINGSGEVAAR – Kleine onderdelen.
- ⚠ Attenzione: RISCHIO DI SOFFOCAMENTO – Pezzi piccoli.
- ⚠ Aviso: PERIGO DE ASFIXIA – Peças pequenas.
- ⚠ Осторожно! ОПАСНОСТЬ УДУШЬЯ – Мелкие детали.



**NORTH AMERICA** – 1-800-622-8339, [customercare@spinmaster.com](mailto:customercare@spinmaster.com)  
**UK** – 0800 206 1191, [serviceuk@spinmaster.com](mailto:serviceuk@spinmaster.com)  
**IRELAND** – 1800 992 249  
**FRANCE** – 0800 909 150, [servicefr@spinmaster.com](mailto:servicefr@spinmaster.com)  
**DEUTSCHLAND** – 00800 0101 0222, [Kundenservice@spinmaster.com](mailto:Kundenservice@spinmaster.com)  
**SCHWEIZ** – 0800 561 350 • **ÖSTERREICH** – 0800 297 247  
**NEDERLAND** – 0800 022 3683, [klantenservice@spinmaster.com](mailto:klantenservice@spinmaster.com)  
**BELGIË/BELGIQUE** – 0800 77 688 • **LUXEMBOURG** – 800 2 8044  
**ITALIA** – 800 788 532, [servizio@spinmaster.com](mailto:servizio@spinmaster.com)  
**MEXICO** – 55 4160 7947, [servicio@spinmaster.com](mailto:servicio@spinmaster.com)



[WWW.SPINMASTER.COM](http://WWW.SPINMASTER.COM)

SPIN MASTER LTD., 450 FRONT STREET WEST, TORONTO, ON M5V 1B6 CANADA.  
DISTRIBUTED IN EU BY SPIN MASTER INTERNATIONAL, S.A.R.L.,  
16 AVENUE PASTEUR, L-2310, Luxembourg. [www.spinmaster.com](http://www.spinmaster.com)  
Made in France by / Fabriqué en France par / Hecho en Francia por  
Meccano: [363.avenue.de.Saint-Exupéry.62100.Calais-France](http://363.avenue.de.Saint-Exupéry.62100.Calais-France)



TM & © 2016 MECCANO for packaging, instructions and models built with this set. / TM & © 2016 MECCANO pour l'emballage, les notices et modèles de ce coffret. / MECCANO ® is an exclusive trademark of MECCANO. Spin Master logo is a trademark of Spin Master Ltd. / MECCANO ® est une marque de commerce exclusive de MECCANO. Le logo de Spin Master est une marque de commerce de Spin Master Ltd. / All rights reserved. / Tous droits réservés.

T91785\_0010\_20074546\_GML\_IB\_R1\_MEC\_Sport Car\_FR\_F16